



PDV-550M Public Address Matrix Amplifier 5x50W 5zone



952.072 PDV-550M
Matrix Amplifier 5x 50W 5 Zone

SAFETY INSTRUCTIONS



The symbol is used to indicate that some hazardous live terminals are involved with in this apparatus, even under the normal operating conditions.



The symbol is used in the service documentation to indicate that specific component shall be only replaced by the component specified in that documentation for safety reasons.

- ⊕ Protective Ground Terminal
- ~ AC mains (Alternating Current)
- ⚡ Hazardous Live Terminal

ON: Denotes the apparatus turns on.

OFF: Denotes the apparatus turns off, because of using the single pole switch, be sure to unplug the AC power to prevent any electric shock before you proceed you service.

WARNING:

Describes precautions that should be observed to prevent the danger of injury or death to the user.



Disposing of this product should not be placed in municipal waste and should be separate collection.

CAUTION:

Describes precautions that should be observed to prevent damage to the apparatus.

WARNING

- **Power supply**
Ensure the source voltage matches the voltage of the power supply before turning ON the apparatus.
Unplug this apparatus during lightning storms or when unused for long periods of time.
- **External Connection**
The external wiring connected to the output hazardous live terminals requires installation by an instructed person, or the use of ready-made leads or cords.
- **Do not Remove any Cover**
There are maybe some are as with high voltages inside, to reduce the risk of electric shock, do not remove any cover if the power supply is connected, The cover should be removed by the qualified personnel only.
No user serviceable parts inside.
- **Fuse**
To prevent a fire, make sure to use fuses with specified standard (current ,voltage, type). Do not use a different fuse or short circuit the fuse holder.
Before replacing the fuse, turn OFF the apparatus and disconnected the power source.
- **Protective Grounding**
Make sure to connect the protective grounding to prevent any electric shock before turning ON the apparatus.
Never cut off the internal or external protective grounding wire or disconnect the wiring of protective grounding terminal.

● Operating Conditions

This apparatus shall not be exposed to dripping or splashing and that no objects filled with liquids, such as vases, shall be placed on this apparatus. To reduce the risk of fire or electric shock, do not expose this apparatus to rain or moisture.
Do not use this apparatus near water. Install in accordance with the manufacturer's instructions, Do not install near any heat sources such as radiators, heat registers, stoves, or other apparatus (including amplifiers) that produce heat. Do not block any ventilation openings. No naked flame sources, such as lighted candles, should be placed on the apparatus.

IMPORTANT SAFETY INSTRUCTIONS

- Read these instructions
 - Follow all instructions
 - Keep these instructions
 - Heed all warnings
 - Only use attachments / accessories specified by the manufacturer
- ### ● Power cord and plug
- Do not defeat the safety purpose of the polarized or grounding type plug. A polarized plug has two blades with one wider than the other. A grounding type plug has two blades and a third grounding prong. The wide blade or the third prong are provided for your safety. If the provided plug does not fit into your outlet, consult an electrician for replacement of the obsolete outlet. Protect the power cord from being walked on or pinched particularly at plugs, convenience receptacles, and the point where they exit from the apparatus.

● Cleaning

When the apparatus needs a cleaning, you can blow off dust from the apparatus with a blower or clean with rag etc. Don't use solvents such as benzol, alcohol, or other fluids with very strong volatility and flammability for cleaning the apparatus body, Clean only with dry cloth.

● Servicing

Refer all servicing to qualified personnel, To reduce the risk of electric shock, do not perform any servicing other than that contained in the operating instructions unless you are qualified to do so. Servicing is required when the apparatus has been damaged in any way, such as power supply cord or plug is damaged, liquid has been spilled or objects have fallen into the apparatus, the apparatus has been exposed to rain or moisture, does not operate normally or has been dropped.

GENERAL DESCRIPTION AND FEATURES

DESCRIPTION

They are designed for PA system applications such as paging, announcements, intercommunications, background music and broad-casting in industrial plants, offices, schools, churches, department stores, shopping centres, night clubs, dining rooms, convention halls, auditoriums and recreation areas.

More kinds of protective for this series: such as overload, short-circuits of output, overheat; and you can use it safely and freely. It's very simple to install, it also can offer the rack brackets according to your requirements.

The series amplifiers come with 2 microphone inputs, 4 auxiliary inputs and Microphone inputs are used with unbalanced microphone. Auxiliary inputs are provided for high level signal sources such as radio tuner, tape recorder, mixer pre amplifier, remote microphone and record player with ceramic or crystal type cartridge. Speaker outputs are complete with 4ohm, 8 ohm, 70V and 100V on the terminal strip. An auxiliary output is equipped for a booster amplifier and a AUX output is equipped for a tape Recorder.

Each input volume can be controlled with the corresponding individual input volume control and can further be adjusted by means of a master volume control and individual bass and treble tone controls.

FEATURES

- Two MIC inputs
- Four AUX inputs.
- Two high level input.
- MIC1 mute other inputs.
- Five zone output .
- Source select switches.
- Each channel have individual potentiometer.
- BASS and TREBLE tone control.
- Multi-purpose protection---power-on-delay, over heat, over voltage, over load.
- Output---8 Ω , 70V, 100V.
- Low distortion.
- High signal-noise rated(S/N).
- Widely frequency response.
- Perfect sound with PA speaker.

FRONT PANEL

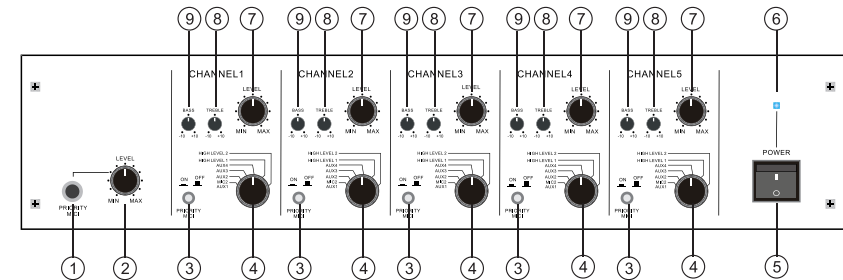

1. INPUT JACK

It is used for microphone1 input.

2. MICROPHONE INPUT VOLUME CONTROL

When it is at min, the volume is lowest; it is at max, the volume is highest.

3. PRIORITY SWITCHES

When the switch is ON, the mic can mute this channel.

4. SOURCE SELECT

To select the input source.

5. POWER SWITCH

This switch is used to turn the main power ON and OFF.

6. INDICATOR

This LED will illuminate when power is turned on.

7. VOLUME CONTROL

When it is at min, the volume is lowest; it is at max, the volume is highest.

8. TREBLE CONTROL

This knob is used to attenuate or boost a high frequency of 10khz by ± 10 dB.

9. BASS CONTROL

This knob is used to attenuate or boost a low frequency of 100hz by ± 10 dB.

REAR PANEL

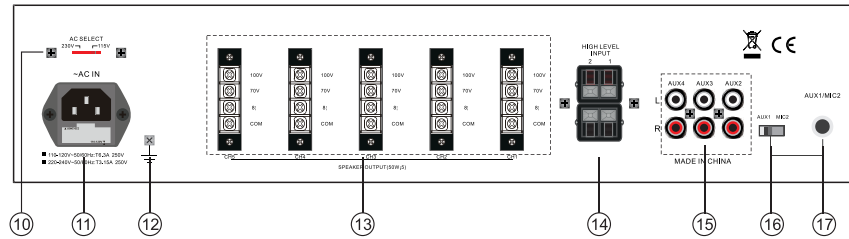

10. VOLTAGE SWITCH

This switch is used to select voltage (115V / 230V) as requirement.

11. AC CONNECTOR AND AC FUSE

This connector is meant for the connection of the supplied mains cord, The fuse protects the alternating currents supply circuit of the equipment. The fuse can only be changed in the event of a fault.

12. "GND" SCREW

In case the used mains outlet does not provide a ground conductor, this screw offers the possibility to ground the amplifiers metal parts. Nevertheless, you should leave this procedure to the experienced, qualified electrician.

13. OUTPUT TERMINALS

These 4 terminals allow connecting speakers.

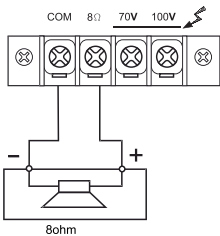

Connecting the speakers to 8 ohm output

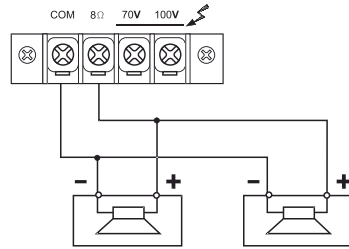

Total impedance 8 ohm

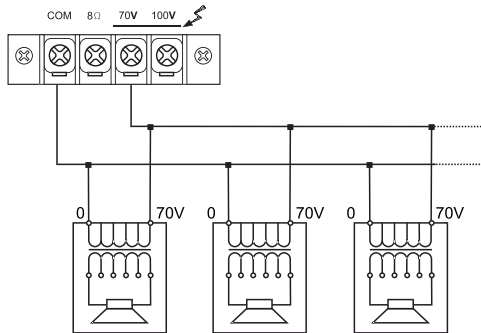

Connecting the speakers to 70V output

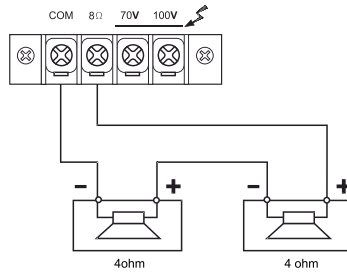

Total impedance 8 ohm

14. HIGH LEVEL INPUT

These two terminals allow the high level signal input.

15. AUX INPUTS

The "R" and "L" sockets permit input of the right ("R") and left ("L") channels of an audio source with a high-level output signal, such as an AM/FM tuner, a cassette deck, a CD player, etc. They are able to take RCA-type coaxial connectors, and unbalanced signals.

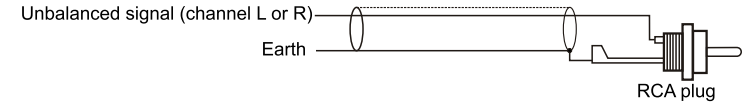

16. AUX1 AND MIC2 SELECT SWITCH

This switch is used to select the AUX1 or MIC2 input.

17. AUX1 AND MIC2 INPUT JACK

This 6.3mm jack allow the AUX1 and MIC2 inputs.

TECHNICAL SPECIFICATION

OUTPUT POWER CAPACITY	RMS: 50W*5 8 Ω
POWER SUPPLY	AC: 110-120V 50/60Hz AC: 220-240V 50/60Hz
FREQUENCY RESPONSE	50Hz~18KHz (\pm 3dB)
INPUT SENSITIVITY	MIC : -50dB AUX : -16dB
TONE CONTROLS	BASS: \pm 10dB (100Hz) TREBLE: \pm 10dB (10KHz)
TOTAL HARMONIC DISTORTION	<0.5%
SIGNAL / NOISE RATIO	MIC: 65dB AUX: 75dB
CONTROLS	MIC LEVEL CONTROL AUX LEVEL CONTROL TONE CONTROL (BASS, TREBLE) AC SWITCH
OUTPUT IMPEACANCE	8 Ω
LINE OUTPUT	70V, 100V
CHIME FUNCTION	NO
VU-METER (LED)	NO
TELEPHONE PAGING LELECT FUNCTION	NO
INPUT 1 PRIORITY	YES
ECHO FUNCTION	NO
MP3 PLAYER	NO
DIMENSION	420*340*88.8mm

EXAMPLE OF POSSIBLE CONNECTIONS

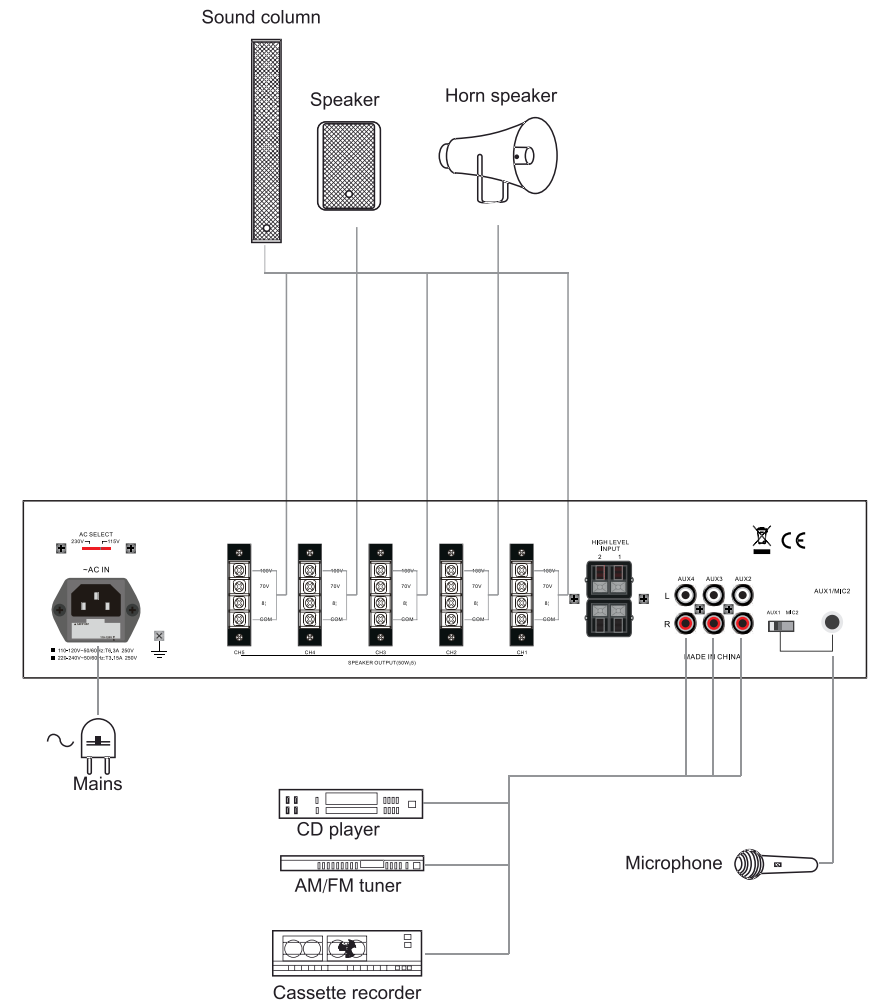



CE Declaration of Conformity

Importer: TRONIOS BV
Bedrijvenpark Twente 415
7602 KM – ALMELO
The Netherlands

Tel: 0031546589299
Fax: 0031546589298

Product number: **952.072**

Product Description: **PDV550M 100V Matrix amp.
5x50W 5zone**

Regulatory Requirement: EN 60065
EN 55013
EN 55020
EN 61000-3-2
EN 61000-3-3

The product meets the requirements stated in the above mentioned Standards.

13-12-2012

Signature :

www.tronios.com